

No More Total Darkness  
High-performance IR LED Camera

SIR-4150

## imagine Seeing in Total Darkness

A high-performance IR camera, the SIR-4150 provides high-resolution video images regardless of day or night, and it can detect and distinguish a moving subject in a pitch-dark environment with 0 Lux minimum illumination. Equipped with various features for advanced functions such as high-resolution video images, ICR Day & Night feature, Vari-Focal Lens and outdoor camera housing ensures you have the most reliable 24-hours a day video surveillance that provide clean and vivid image for all major areas including : military bases, ammunition dumps, outskirts of factories and small-sized stores.



SAMSUNG TECHWIN



# Zero Zone for Light...

## Eyes that Light up in Pitch Black Conditions

### High-performance **IR LED** Camera, **SIR-4150**



The SIR-4150 provides high-resolution video images regardless of day or night, and it can detect and distinguish a moving subject in a pitch-dark environment with 0 Lux minimum illumination.



**Vari-Focal Lens** provides a more flexible surveillance environment

High-performance **IR LEDs** ensure all-weather day and night surveillance

**Outdoor camera housing** is designed for easy installation

# See in Total Darkness...

## Total Darkness - a thing of the past! 0 Lux Minimum Illumination! The ultimate night surveillance system, **SIR-4150**

The SIR-4150 is a high-performance IR LED camera with various features for advanced functions such as high-resolution video images, ICR Day & Night feature, Vari-Focal Lens and outdoor camera housing, which ensures you have the most reliable 24-hours a day video surveillance providing clean and vivid images for all places, including : military bases, ammunition dumps, outskirts of factories and commodity stores.

### 0 Lux Minimum Illumination that monitors in total darkness!

The SIR-4150 is equipped with high-performance IR LEDs that can detect and visualize even the small movement of subjects in total darkness without any light. It can be trusted to deliver the most reliable video surveillance by providing you with vivid color video images during the day and high resolution black and white images during the night.



Conventional Camera



SIR-4150

### High-resolution of 570TV lines that provides clearer images even at night time

The combination of a Super HAD CCD image sensor with outstanding performance and a WIII DSP system with high-efficiency processing enables the SIR-4150 to give you clear horizontal resolution of over 570TV lines in B/W mode.

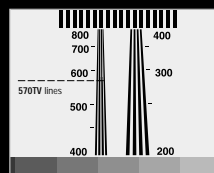

EIAJ Test Chart



SIR-4150

### Day & Night (ICR type) feature for 24-hour Complete Monitoring

The SIR-4150 provides you with the ICR True Day & Night feature. It automatically removes the IR filters when night falls and switches to B/W mode to provide high image resolution during the night.



Day



Night

# Detect Every Move...



- **SSNR** provides vivid images with less DVR capacity

The SIR-4150 applies Samsung Techwin's world-renowned noise reduction technology SSNR to eliminate any noise or after image associated with night environments, which can give the additional benefit of reducing the video file size to substantially reduce the DVR capacity by up to 70%.

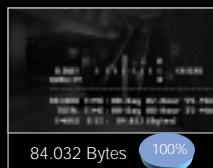

SSNR Off

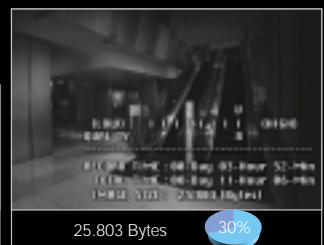

SSNR On

- **Privacy Area Masking** feature. **Wide Range White Balance** feature

The SIR-4150's Privacy Area Masking feature lets you create a "privacy masking" over up to 4 zones of certain areas that are sensitive to be under surveillance, and the Wide Range White Balance feature provides you with optimum image quality even when used in poor surroundings like tunnels or sodium lighting.



Privacy Area Masking



White Balance

- **Convenient RS-485** remote control support for OSD menu

The SIR-4150 supports RS-485 communication for remotely controlling the OSD menu, which means you can conveniently change the setting for the camera without having to visit the installation location.



SCC-100 (OSD Controller)

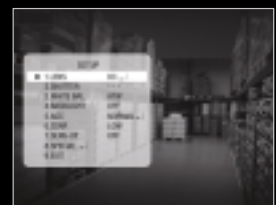

No place to Hide...



## The Perfect 24-hour Security Solution High-performance Camera, **SIR-4150**

- **Vari-Focal Lens (f3.8~9.5mm)** for a more flexible surveillance

The SIR-4150 is equipped with a Vari-Focal Lens of f3.8~9.5mm that ensures optimum video image and focus setting so that you get the best view of the surveillance environment. It can be utilized in various installation environments.



2.5X



Normal

- **High Performance IR LEDs** Ensures **4 times** Higher Brightness

The SIR-4150 incorporates high performance IR LED lamps that provides upto 4 times higher brightness than ordinary LEDs allowing for clearer images and more accurate identification in complete darkness. The IR illuminators also withstands high temperature upto 100°C enabling the camera to function with a high degree of reliability and have a long life.



- **Outstanding durability with IP65's Waterproof and Dustproof function & Sun Shield function**

The SIR-4150 provides the IP65 certificate's outstanding Waterproof and Dustproof function that allows it to be used in all climates, and the Sun Shield function increases the high temperature durability to ensure safety of the product under outdoor environmental conditions.



- **Long Range Visibility of 30m** in Complete Darkness

The IR LEDs of the SIR-4150 automatically illuminates viewing area in the extreme darkness allowing the camera a long-range visibility of up to 30 meters.



Day & Night IR LED Camera with Built-in Vari-Focal Lens

# SIR-4150



## Specifications

Mode	SIR-4150N	SIR-4150P
Power Source	12V DC ( $\pm 10\%$ )	
Power Consumption	Max. 5.5W (LED On)	
Image Pick-up Device	1/3" Super HAD CCD	
Total Pixels	811(H) x 508(V)	795(H) x 596(V)
Effective Pixels	768(H) x 494(V)	752(H) x 582(V)
Scanning System	2 : 1 Interlace 525 Lines / 60 Fields / 30 Frames	2 : 1 Interlace 625 Lines / 50 Fields / 25 Frames
Synchronization	Internal / Line lock selectable	
Scanning Frequency	Horizontal : 15,734KHz / Vertical : 59.94Hz	Horizontal : 15,625KHz / Vertical : 50Hz
Horizontal Resolution	Color : 520TV lines (Min.) / B/W : 570TV lines (Min.)	
Min. Illumination	LED On	0 Lux@F1.2 (B/W mode)
	LED Off	0.3Lux@F1.2 (Normal color mode) 0.002Lux@F1.2 (Sens-up mode)
Video Output	1.0Vp-p / 75 $\Omega$ (Video 0.714Vp-p, Sync 0.286Vp-p)	1.0Vp-p / 75 $\Omega$ (Video 0.7Vp-p, Sync 0.3Vp-p)
Lens	2.5X Auto iris varifocal lens (F1.2, f3.8 - 9.5mm)	
IR LED	24ea	
IR Distance	30m	
Water Resistance	IP65	
S / N Ratio (Y signal)	50dB (AGC off, Weight on)	
Day & Night	Color / B/W / Auto selectable (ICR filter change)	
Gain Control	Low / Middle / High / Off selectable	
White Balance	ATW / AWC / Manual selectable (1800°K ~ 10,500°K)	
Electronic Shutter Speed	Auto / Manual selectable (1/60 ~ 1/120,000sec)	Auto / Manual selectable (1/50 ~ 1/120,000sec)
Sens-up	On / Off (Selectable limit ~ 128X)	
OSD	Built-in	
SSNR	Low / Middle / High / Off selectable	
Motion Detection	On / Off selectable (Output via terminal)	
Privacy Function	On / Off selectable (4 Programmable zones per screen)	
Mirror	On / Off selectable	
Sharpness	On / Off selectable	
Max. Aperture Ratio	1 : 1.2 ~ 2.1	
Focus Control	Auto / Manual / One push selectable	
Iris Control	Auto / Manual selectable	
Communication	RS-485 (Pelco-D)	
Operating Temperature	-10°C ~ +50°C	
Operating Humidity	30% ~ 80% RH	
Dimensions	74(W) x 74(H) x 134.5(D)mm	
Weight	585g	
Option	Remote controller	

## Dimensions

Unit : mm

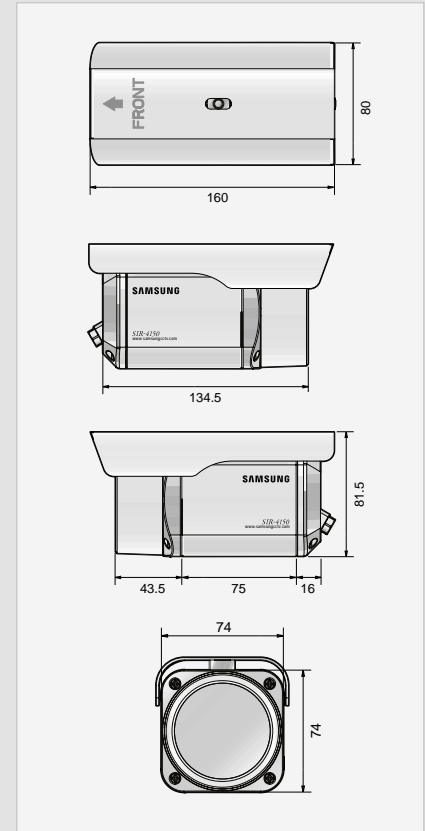

## Controller (Option)



The Eco mark represents Samsung Techwin's will to create environment-friendly products, and indicates that the product satisfies the EU RoHS Directive.



**SAMSUNG TECHWIN CO., LTD.**  
333-1, Sangdaewon 1-dong, Jungwon-gu,  
Seongnam-si, Gyeonggi-do Korea 462-807  
Tel : +82-31-730-8931-3 Fax : +82-31-730-8950  
www.samsungcctv.com

**TIANJIN SAMSUNG OPTO-ELECTRONICS CO., LTD.**  
7 Pingchang Rd., Nankai Dist. Tianjin 300190, P.R.China  
Tel : +86-22-2761-4724(33821) Fax : +86-22-2761-6514

**SAMSUNG OPTO-ELECTRONICS UK, LTD.**  
Samsung House, 1000 Hillswood Drive,  
Hillswood Business Park Chertsey, Surrey KT16 0PS  
Tel : +44-1932-45-5308 Fax : +44-1932-45-5325

Design and specifications are subject to change without notice.

DISTRIBUTED BY

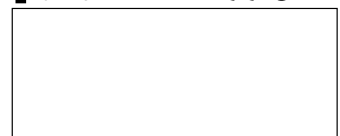

I.D-0706